

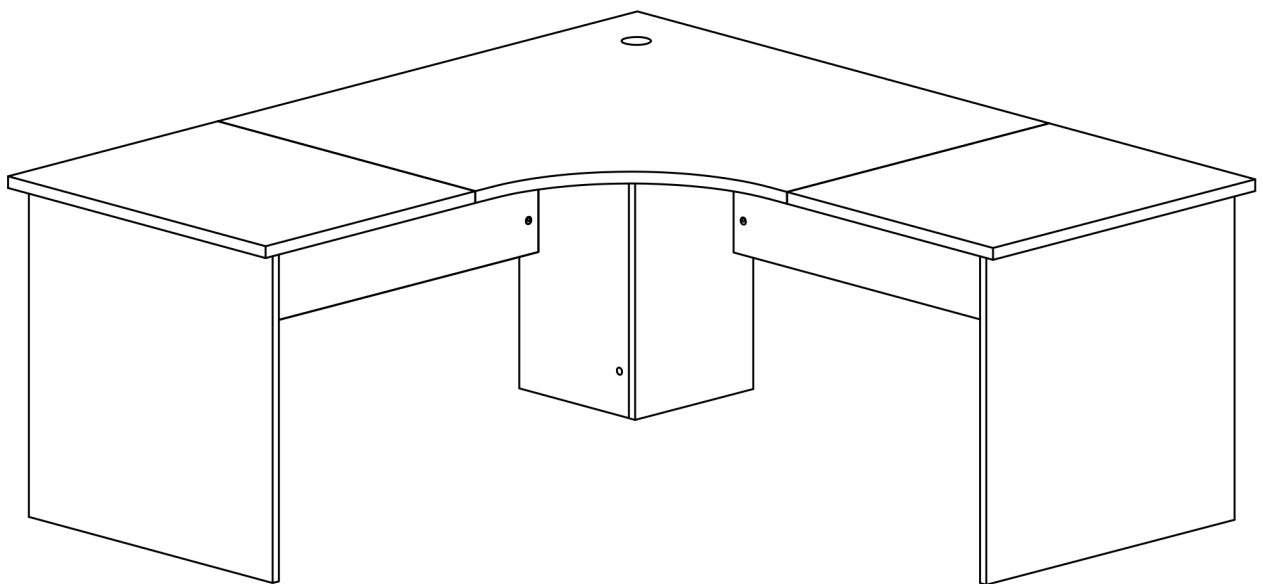





# Office FURNITURE Brisbane

**ASSEMBLY INSTRUCTIONS  
WORKSTATIONS  
R20-WS**

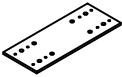

<p>pin 6×35</p>  <p>①</p> <p>30PCS</p>	<p>Dowel 8×30</p>  <p>②</p> <p>30PCS</p>	<p>Cam Cover</p>  <p>③</p> <p>42PCS</p>	<p>CONNECTOR</p>  <p>④</p> <p>2PCS</p>	<p>SCREW 6×12</p>  <p>⑤</p> <p>8PCS</p>	<p>SCREW 4×16</p>  <p>⑥</p> <p>8PCS</p>
---	---	--	---	--	--

## OPTION 1

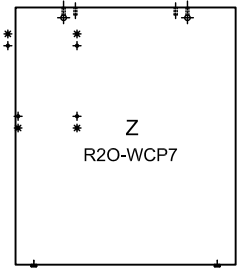
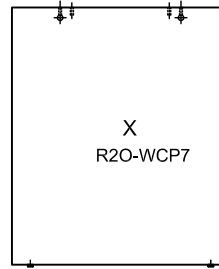
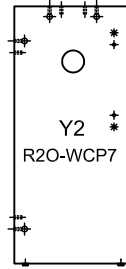
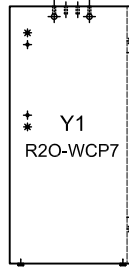
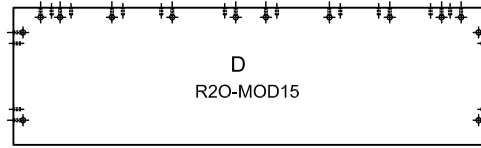
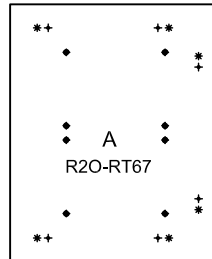
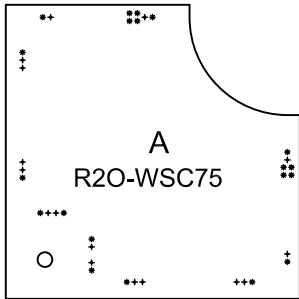

## 1

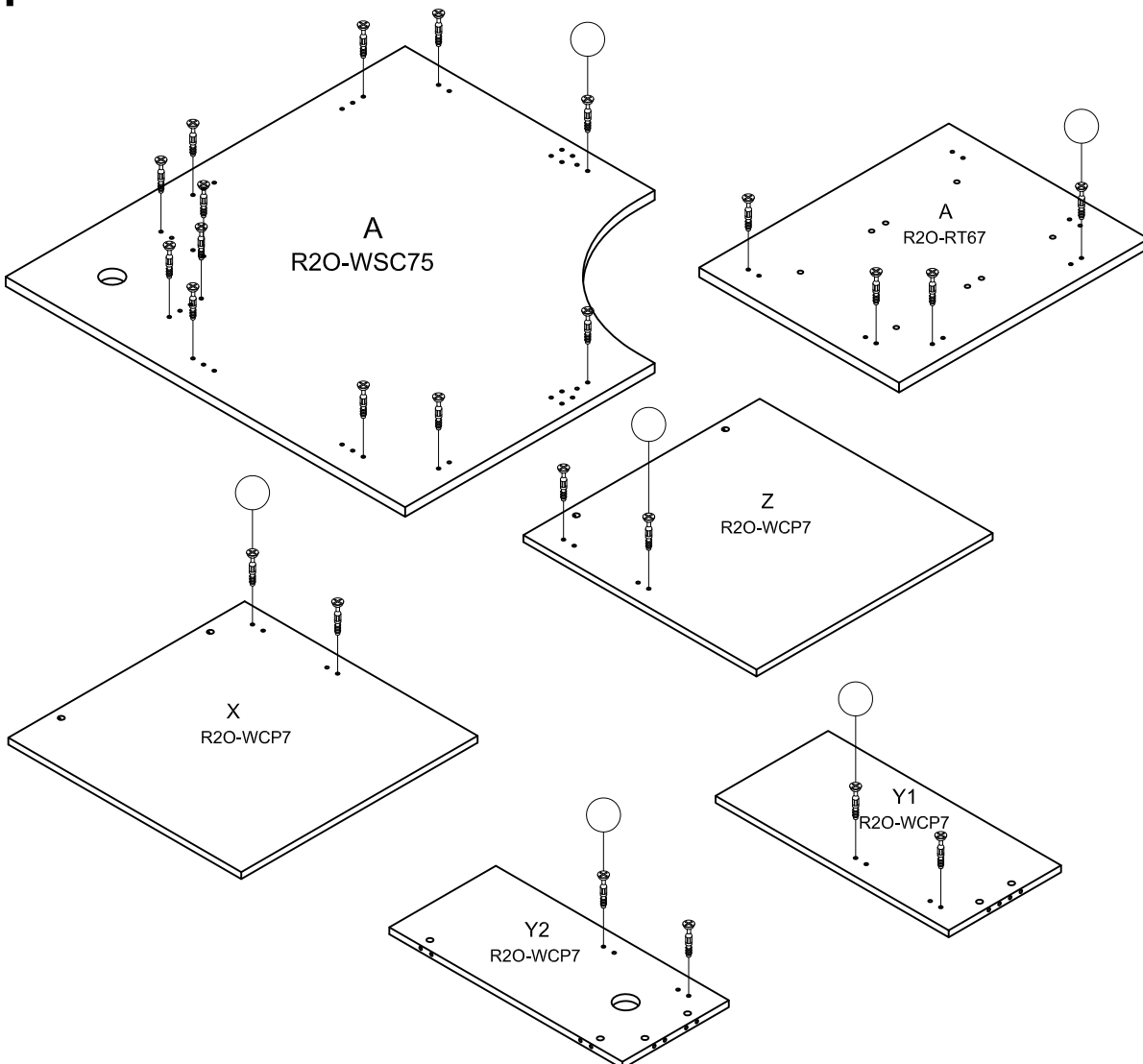

1

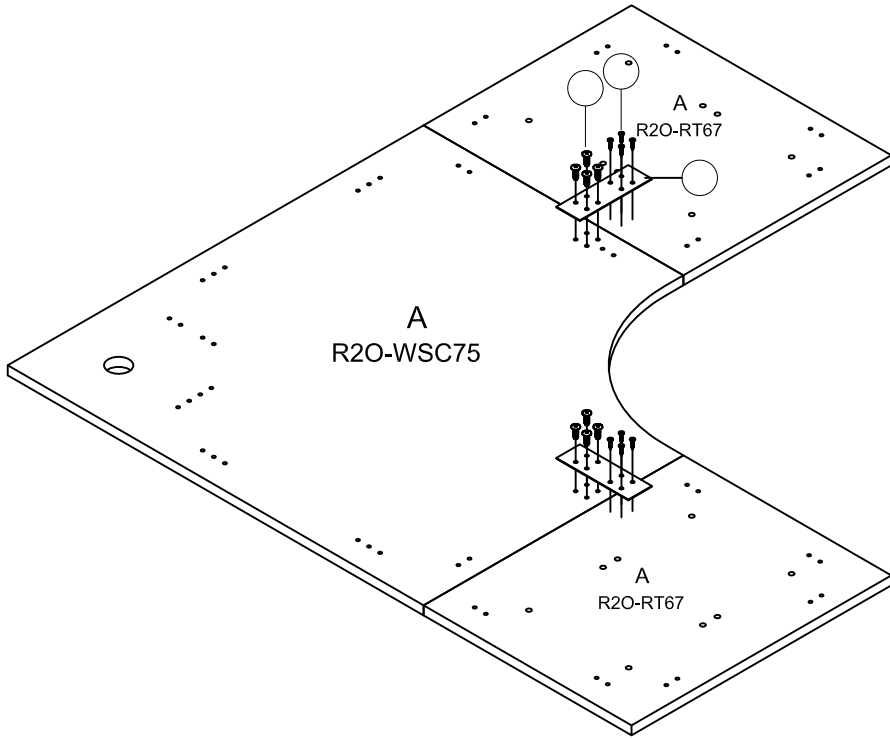

2

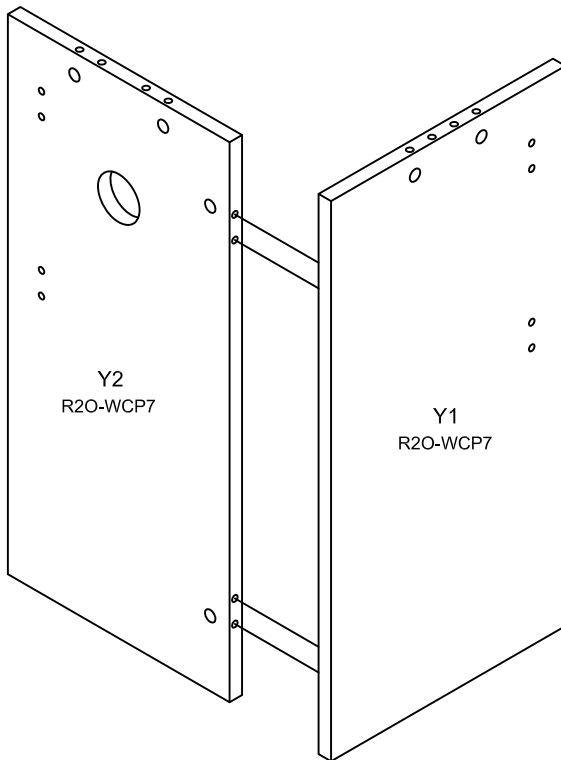

3

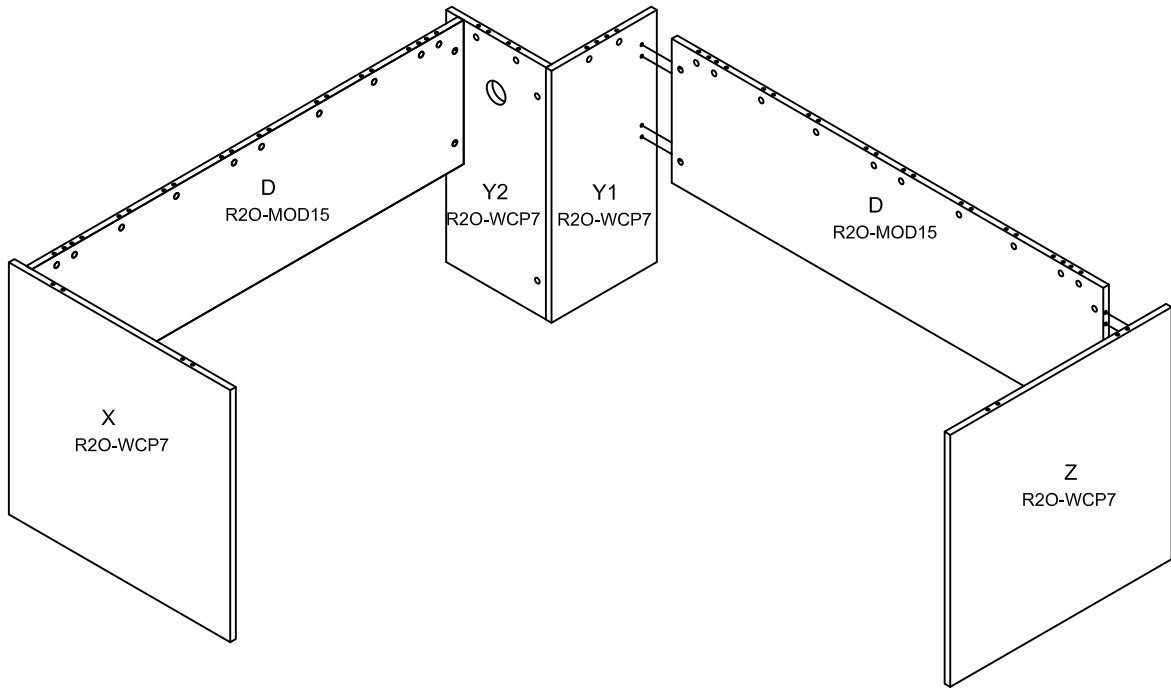

4

